



440G-LZ Guard Locking Safety Switch

Catalog Numbers 440G-LZS21SJJ, 440G-LZS21SJRJ, 440G-LZS21SPLA, 440G-LZS21SPLB, 440G-LZS21SPLH, 440G-LZS21SPRA, 440G-LZS21SPRB, 440G-LZS21SPRH, 440G-LZS21STLA, 440G-LZS21STLB, 440G-LZS21STLH, 440G-LZS21STRA, 440G-LZS21STRB, 440G-LZS21STRH, 440G-LZS21UJLJ, 440G-LZS21UJRJ, 440G-LZS21UPLA, 440G-LZS21UPLB, 440G-LZS21UPLH, 440G-LZS21UPRA, 440G-LZS21UPRB, 440G-LZS21UPRH, 440G-LZS21UTLA, 440G-LZS21UTLB, 440G-LZS21UTLH, 440G-LZS21UTRA, 440G-LZS21UTRB, 440G-LZS21UTRH



ATTENTION: Read this document and the documents that are listed in the Additional Resources section about installation, configuration, and operation of this equipment before you install, configure, operate, or maintain this product. Users are required to familiarize themselves with installation and wiring instructions, and requirements of all applicable codes, laws, and standards.

Activities including installation, adjustments, putting into service, use, assembly, disassembly, and maintenance are required to be carried out by suitably trained personnel in accordance with applicable code of practice.

If this equipment is used in a manner not specified by the manufacturer, the protection provided by the equipment may be impaired.

Additional Resources

The QR code on the switch provides a link to publication 440G-UM001A-EN-P.

Resource	Description
440G-LZ Guard Locking Switch User Manual, publication 440G-UM001A-EN-P	Provides general guidelines for installing a Rockwell Automation guard locking switch.
Industrial Automation Wiring and Grounding Guidelines, publication 1770-4.1	Provides general guidelines for installing a Rockwell Automation industrial system.
Product Certifications website, http://www.rockwellautomation.com/products/certification	Provides declarations of conformity, certificates, and other certification details.

You can view or download publications at <http://www.rockwellautomation.com/literature/>. To order paper copies of technical documentation, contact your local Allen-Bradley distributor or Rockwell Automation sales representative.

Topic	Page
Summary of Changes	1
Additional Resources	1
Introduction	1
Mounting	2
Installation Considerations	2
Auxiliary/Manual Release	3
Connections	4

Introduction



ATTENTION: Do not attempt to install this device unless the installation instructions have been studied and understood. This document acts as a guide for a typical installation and is available in some languages at www.rockwellautomation.com/literature. Select the publication language and type 440G-LZ in the search field. A user manual is also available, publication [440G-UM001A-EN-P](#).

Summary of Changes

Added required minimum distance between switches and detail for 5-pin quick-disconnect models.

Figure 1 - Assembly Overview

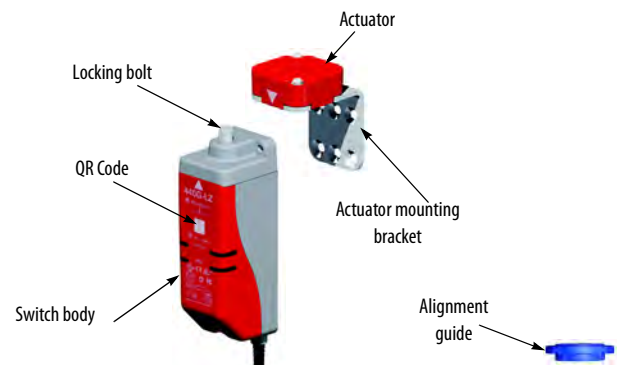

This 440G-LZ Guard Locking switch is for use on guards that are engineered to be rigid without sag. A separately mounted latch (for example, magnetic, mechanical) and mechanical stop is required.

Installation must be in accordance with these instructions and must be carried out by qualified personnel.



ATTENTION: After installation, ensure that there is no possibility of lifting the actuator over the extended locking bolt. Adherence to the recommended maintenance instructions forms part of the warranty.

This device is intended to be part of the safety-related control system of a machine. Before installation, a risk assessment must be performed to determine whether the specifications of this device are suitable for all foreseeable operational and environmental characteristics of the application. See Specifications on [page 5](#) for certification information and ratings.

Use appropriate screws, bolts, or nuts that are fitted by tools to mount the switch and actuators to avoid the risk of tampering. Do not over torque the mounting hardware.

Mounting

Figure 2 - Switch Body and Actuator

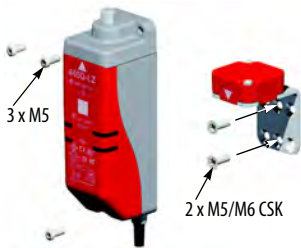

For proper installation, a minimum of two fasteners must be used, at least one of which must be fitted to the top row of holes, closest to the bend in the actuator mounting bracket.



ATTENTION: For the switch, actuator and actuator mounting bracket:

- Only use the designated mounting holes.
- Never drill or use to support other structures such as conduit, cable ways, or other hardware.

Figure 3 - Actuator Mounting Possibilities

The locking bolt must always enter the actuator mounting bracket first.



Installation Considerations

Figure 4 - Orientation of Assembled Switch



Minimum Distance Between Switches

If a pair of 440G-LZ switches is mounted close to each other, the two inductive fields interact causing crosstalk, which results in nuisance faults and false operation.

An absolute minimum of 200 mm (8 in.) must be used to help achieve correct operation.

The restriction applies if a 440G-LZ switch is mounted close to the TLS-Z guard locking and the 440N-Z SensaGuard™ switches.

Figure 5 - Minimum Distance between Switches

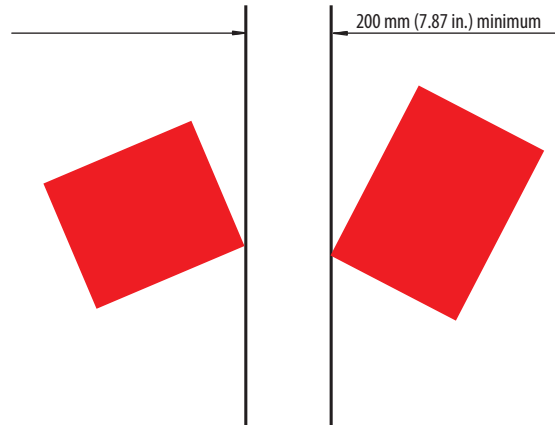

Figure 6 - Four Directions of Approach

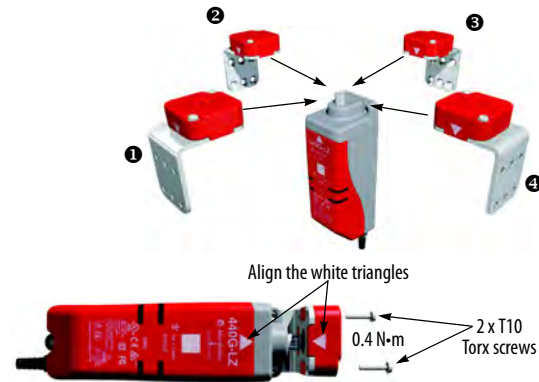
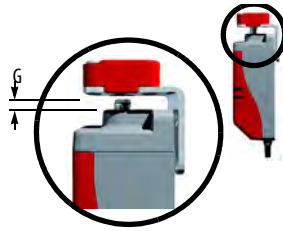

Figure 7 - Actuator Alignment (Three Methods)

1. By setting gap "G"
2.5 mm (0.09 in.)
[0...5 mm (0...0.19 in.)]



2. By mounting hole alignment
"H" 6.5 mm (0.25 in.)
[4...9 mm (0.15...0.35 in.)]



3. By use of the Alignment Guide

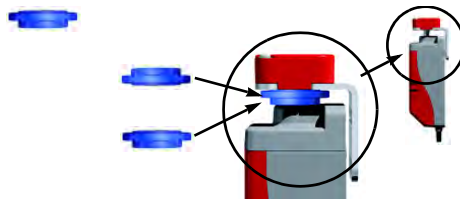

IMPORTANT It might be easier to achieve actuator alignment by first mounting just the actuator mounting bracket to the guard/door and then fit the actuator to its mounting bracket.
It is not possible to mechanically extend the locking bolt during installation, this can only be done electrically (see Commissioning in the user manual).



ATTENTION: After installation, be sure that there is no possibility of lifting the actuator over the extended locking bolt.



After installation, be sure that there is no possibility of collision when the actuator approaches the switch body.



Auxiliary/Manual Release

Operation of the auxiliary release causes a fault condition.
To reset the switch, cycle the power.

Figure 8 - Manual Release Operation [mm (in.)]

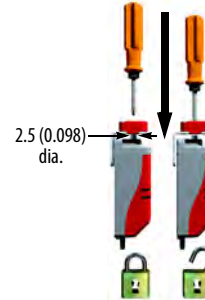
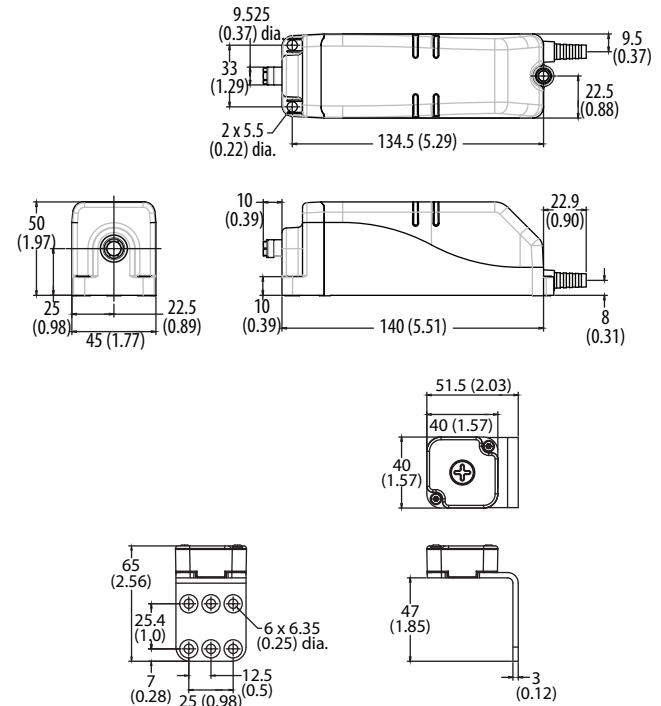

Figure 9 - Dimensions [mm (in.)]



See publication [440G-UM001](#), for configuring Unique Actuators.

Connections

Figure 10 - Eight-pin Micro (M12) or Cable Version

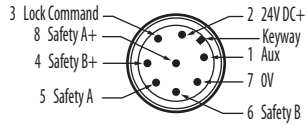

Color	Function	Pin
White	Aux	1
Brown	24V DC+	2
Green	Lock	3
Yellow	Safety B+	4
Grey	Safety A	5
Pink	Safety B	6
Blue	Gnd/0V	7
Red	Safety A+	8

The recommended cordset is catalog number 889D-F8AB-2 (2 m [6.5 ft]). For additional lengths, replace the 2 with a 5 (5 m [16.4 ft]), or 10 m (32.8 ft) for standard cable lengths.

Five-pin Micro (M12)

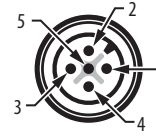

Pin	Color	Function
1	Brown	+24
2	White	Safety OSSD 1 Output
3	Blue	0V
4	Black	Safety OSSD2 Output
5	Gray	Lock Command

The recommended cordset is catalog number 889D-F5AC-2 (2 m [6.5 ft]). For additional lengths, replace the 2 with 5 [5 m (16.4 ft)] or 10 [10 m (32.8 ft)] for standard cable lengths.

The recommended patchcord for use with ArmorBlock® Guard Safety I/O is the 2 m (6.5 ft) catalog number 889D-F5ACDM-2. Replace the 2 with 0M3 [0M3 (0.98 ft)], 1 [1 m (3.28 ft)], 5 [5 m (16.4 ft)], or 10 [10 m (32.8 ft)] for standard cable lengths.

Specifications

Standards	IEC 60947-5-3, IEC 60947-5-1, IEC 61508, EN ISO 13849-1, IEC 62061, ISO 14119, UL 508
Safety classification: Guard door sensing and lock monitoring	PLe Category 4 per ISO 13849-1, SIL 3 per IEC 61508 and IEC 62061
Functional Safety Data: Guard door sensing and lock monitoring	PFHd: 9.1×10^{-10} ; Dual channel interlock can be suitable for use in application up to PLe (according to ISO 13849-1) and for use up to SIL3 systems (according to IEC 62061 and IEC 61508) depending on application characteristics. Mission time/PTI: 20 years
Certifications	CE Marked for all applicable EU directives, c-UL-us (UL 508), TÜV, C-tick
Operating Characteristics	
Torque for M5 mounting of switch and actuator mounting bracket	2 N·m (17.7 lb-in) max
Locking bolt insertion for assured locking and holding force	5 mm (0.19 in.) min, 10 mm (0.39 in.) max
Locking bolt alignment tolerance X, Y, Z	±2.5 mm (0.09 in.) max
Holding force Fmax (EN/ISO 14119)	1690 N
Holding force Fzh (EN/ISO 14119)	1300 N
Maximum output current (each outputs)	200 mA
Quiescent power consumption, locked or unlocked	2.5 W
Lock signal current	3.5 mA signal on green lock/unlock wire
Peak current and duration, at turn on or after lock/unlock operation	400 mA/100 ms
Operating voltage Ue	24V DC +10% / -15% Class 2 SELV
Maximum frequency of operating cycles	0.2 Hz
Dwell time between subsequent locking/unlocking	2.5 s
Response time (Off)	100 ms first switch, 50 ms additional for each switch
Risk time	100 ms (according to IEC 60947-5-3)
Start up time (availability)	5 s
Maximum length of a chain of switches	10 km (Dependent on cable/connection/required response time)
Utilization category (IEC 60947-5-2)	DC-13 24V 200 mA
Insulation voltage Ui (IEC 60947-1)	75V

Operating Characteristics (continued)	
Impulse withstand voltage Uimp (IEC 60947-1)	1 kV
Pollution degree (IEC 60947-1)	3
Manual (auxiliary) release	Built in
Protection class (IEC 61140)	Class II
Mechanical life	500,000 cycles
Outputs (Guard door closed and locked)	
Safety outputs	2 x PNP, 0.2 A max / ON (+24V DC)
Auxiliary outputs	1 x PNP, 0.2 A max / OFF (0V DC)
Environmental	
Operating temperature	0...55 °C (32...131 °F)
Storage temperature	-25...+75 °C (-13...+167 °F)
Operating humidity	5...95% relative
Enclosure ingress rating	NEMA 3, 4X, 12, 13, IP66, IP67, IP69K
Shock and vibration	IEC 60068-2-27 30 g, 11 ms/IEC 60068-2-6 10...55 Hz
Hygienic	ISO 14159:2004 and EN 1672-2005, (for that part of the machine defined as "food splash area")
Washdown	Sodium Hydroxide based washdown fluids
Radio frequency / EMC	IEC 60947-5-3, FCC-1(Parts 18&15), R&TTE
General	
Materials	ABS, locking bolt and mounting bracket 304 stainless steel
Weight switch/actuator	Switch 400 g, actuator 150 g, actuator mounting bracket 60 g
Protection Type	Short-circuit, current limitation, overload, reverse polarity, overvoltage (up to 60V max.), thermal shutdown/restart

Status/Diagnostic Operating LED Indicators

The switch has two pairs of LEDs. Status LEDs are green and diagnostic LEDs are red.

Power to Lock Versions	Door/Guard Status	Lock Command	OSSD Input	Lock Status	LED Status	OSSD Status
Power on and lock command off	Open or closed	Off	Off or on	Unlocked	Blinks 6 x green then solid red	Off
Lock command on and door open	Open	On	Off or on	Unlocked	Fast flash green	Off
Lock command on and door closed	Closed	On	Off	Locked	Slow flash green	Off
Lock command on and door closed	Closed	On	On	Locked	Solid green	On

Power to Release Versions	Door/Guard Status	Unlock Command	OSSD Input	Lock Status	LED Status	OSSD Status
Power on with door open	Open	Off	Off or on	Unlocked	Blinks 6 x green then 1 x blink red followed by fast flash green	Off
Power on with door closed	Closed	Off	Off	Locked	Blinks 6 x green then 1 x blink red followed by slow flash green	Off
Power on with door closed and OSSD input active	Closed	Off	On	Locked	Blinks 6 x green then 1 x blink red followed by solid green	On
Unlock command on and door closed or open	Open or closed	On	Off or on	Unlocked	Solid red	Off

Catalog Numbers for Complete Switches

440G-LZS21

a b c d

a		b		c		d	
S	Standard Coding	J	No Auxiliary (5-pin models)	R	Power-to-Release	A	3 m Cable
U	Unique Coding	P	Auxiliary—Lock Status	L	Power-to-Lock	B	10 Cable
		T	Auxiliary—Door Proximity			H	M12 8-pin
						J	M12 5-pin

Rockwell Automation Support

Use the following resources to access support information.

Technical Support Center	Knowledgebase Articles, How-to Videos, FAQs, Chat, User Forums, and Product Notification Updates.	https://rockwellautomation.custhelp.com/
Local Technical Support Phone Numbers	Locate the phone number for your country.	http://www.rockwellautomation.com/global/support/get-support-now.page
Direct Dial Codes	Find the Direct Dial Code for your product. Use the code to route your call directly to a technical support engineer.	http://www.rockwellautomation.com/global/support/direct-dial.page
Literature Library	Installation Instructions, Manuals, Brochures, and Technical Data.	http://www.rockwellautomation.com/global/literature-library/overview.page
Product Compatibility and Download Center (PCDC)	Get help determining how products interact, check features and capabilities, and find associated firmware.	http://www.rockwellautomation.com/global/support/pcdc.page

Documentation Feedback

Your comments will help us serve your documentation needs better. If you have any suggestions on how to improve this document, complete the How Are We Doing? form at http://literature.rockwellautomation.com/idc/groups/literature/documents/du/ra-du002_-en-e.pdf.

Waste Electrical and Electronic Equipment (WEEE)



At the end of life, this equipment should be collected separately from any unsorted municipal waste.

Rockwell Automation maintains current product environmental information on its website at <http://www.rockwellautomation.com/rockwellautomation/about-us/sustainability-ethics/product-environmental-compliance.page>.

Allen-Bradley, ArmorBlock, Rockwell Automation, Rockwell Software, and SensaGuard are trademarks of Rockwell Automation, Inc. Trademarks not belonging to Rockwell Automation are property of their respective companies.

Rockwell Otomasyon Ticaret A.Ş., Kar Plaza İş Merkezi E Blok Kat:6 34752 İçerenköy, İstanbul, Tel: +90 (216) 5698400

www.rockwellautomation.com

Power, Control and Information Solutions Headquarters

Americas: Rockwell Automation, 1201 South Second Street, Milwaukee, WI 53204-2496 USA, Tel: (1) 414.382.2000, Fax: (1) 414.382.4444
 Europe/Middle East/Africa: Rockwell Automation NV, Pegasus Park, De Kleetlaan 12a, 1831 Diegem, Belgium, Tel: (32) 2 663 0600, Fax: (32) 2 663 0640
 Asia Pacific: Rockwell Automation, Level 14, Core F, Cyberport 3, 100 Cyberport Road, Hong Kong, Tel: (852) 2887 4788, Fax: (852) 2508 1846

Publication 440G-IN011B-EN-P - October 2018

Supersedes Publication 440G-IN011B-EN-P - June 2015

PN-212379

10000818284 Ver 04

Copyright © 2018 Rockwell Automation, Inc. All rights reserved. Printed in the U.S.A.